

Thinking of you

 **Electrolux**

User Manual

Washer-dryer
EWX 14450 W



We were thinking of you
when we made this product

Welcome to the world of Electrolux

Thank you for choosing a first class product from Electrolux, which hopefully will provide you with lots of pleasure in the future. The Electrolux ambition is to offer a wide variety of quality products that make your life more comfortable. You find some examples on the cover in this manual. Please take a few minutes to study this manual so that you can take advantage of the benefits of your new machine. We promise that it will provide a superior User Experience delivering Ease-of-Mind. Good luck!

Contents

Safety information.....	5
Product description	8
Control panel	9
Use.....	12
Washing	12
Drying.....	17
Washing and drying hints	19
Washing programmes.....	23
Programme information	25
Drying time	26
Care and cleaning	27
What to do if.....	31
Technical data	35
Consumption values	35
Installation	36
Building in.....	42
Environment concerns	45

The following symbols are used in this manual:



Important information concerning your personal safety and information on how to avoid damaging the appliance.



General information and tips



Environmental information

Safety Information



In the interest of your safety and to ensure the correct use, before installing and first using the appliance, read this user manual carefully, including its hints and warnings. To avoid unnecessary mistakes and accidents, it is important to ensure that all people using the appliance are thoroughly familiar with its operation and safety features. Save these instructions and make sure that they remain with the appliance if it is moved or sold, so that everyone using it through its life will be properly informed on appliance use and safety.

General safety

- It is dangerous to alter the specifications or attempt to modify this product in any way.
- During high temperature wash programmes the door glass may get hot. Do not touch it!
- Make sure that small pets do not climb into the drum. To avoid this, please check into the drum before using.
- Any objects such as coins, safety pins, nails, screws, stones or any other hard, sharp material can cause extensive damage and must not be placed into the machine.
- Only use the advised quantities of fabric softener and detergent. Damage to the fabric can ensue if you over-fill. Refer to the manufacturer's recommendations of quantities.
- Wash small items such as socks, laces, washable belts etc in a washing bag or pillow case as it is possible for such items to slip down between the tub and the inner drum.
- Do not use your washer-dryer to wash and dry articles with whalebones, material without hems or torn material.
- Always unplug the appliance and turn off the water supply after use, cleaning and maintenance.
- Under no circumstances should you attempt to repair the machine yourself. Repairs carried out by inexperienced persons may cause injury or serious malfunctioning. Contact your local Service Centre. Always insist on genuine spare parts.

Installation

- This appliance is heavy. Care should be taken when moving it.
- When unpacking the appliance, check that it is not damaged. If in doubt, do not use it and contact the Service Centre.
- All packing and transit bolts must be removed before use. Serious damage can occur to the product and to property if this is not adhered to. See relevant section in the user manual.
- After having installed the appliance, check that it is not standing on the inlet and drain hose and the worktop is not pressing the electrical supply cable.
- If the machine is situated on a carpeted floor, please adjust the feet in order to allow air to circulate freely under the appliance.
- Always be sure, that there is no water leakage from hoses and their connections after the installation.

- If the appliance is installed in a location subject to frost, please read the “**dangers of freezing**” chapter.
- Any plumbing work required to install this appliance should be carried out by a qualified plumber or competent person.
- Any electrical work required to install this appliance should be carried out by a qualified electrician or competent person.

Use

- This appliance is designed for domestic use. It must not be used for purposes other than those for which it was designed.
- Only wash fabrics which are designed to be machine washed. Follow the instructions on each garment label.
- Do not overload the appliance. See the relevant section in the user manual.
- Before washing, ensure that all pockets are empty and buttons and zips are fastened. Avoid washing frayed or torn articles and treat stains such as paint, ink, rust, and grass before washing. Underwired bras must NOT be machine washed.
- As some duvets and eiderdowns should be washed/dried in large commercial machines because of their bulk, please check with the manufacturer of the item before washing in a domestic machine.
- The users should always check that they have not left their gas lighters (disposable or otherwise) in their clothing.
- Never tumble dry items that have had contact with chemicals such as dry cleaning fluid. These are of a volatile nature and could cause an explosion.
Only tumble dry items which have been washed in water or require air-ing.
- Plastic detergent dispensers should not remain in the drum during the drying cycle, as the plastic used is not designed to withstand the heat. If you wish to wash-through-to-dry you should use the conventional detergent dispenser drawer.
- Garments which have been in contact with volatile petroleum products should not be machine washed. If volatile cleaning fluids are used, care should be taken to ensure that the fluid is removed from the garment before placing in the machine.
- Never pull the power supply cable to remove the plug from the socket; always take hold of the plug itself.
- Never use the appliance if the power supply cable, the control panel, the working surface or the base are damaged so that the inside of the washer dryer is accessible.
- Leave the porthole door slightly ajar between washes to preserve the door seal.

Child safety

- This appliance is not intended for use by person (including children) with reduced physical sensory or mental capabilities or lack of experience and knowledge unless they have been given supervision or instruction concerning use of the appliance by a person responsible for their safety.
- The packaging components (e.g. plastic film, polystyrene) can be dangerous to children - danger of suffocation! Keep them out of children's reach
- Keep all detergents in a safe place out of children's reach.
- Make sure that children or pets do not climb into the drum. To prevent children or pets becoming trapped inside, this the machine incorporates special feature. To activate this device, rotate the button (without pressing it) inside the door clockwise until the groove is horizontal. If necessary use a coin.

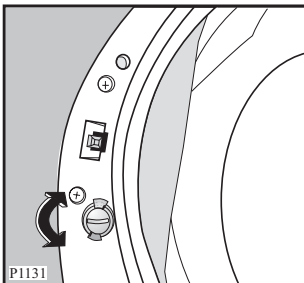

To disable this device and restore the possibility of closing the door, rotate the button anti-clockwise until the groove is vertical.

Product description

Your new appliance meets all modern requirements for effective treatment of laundry with low water, energy and detergent consumption.

The **ECO valve** system allows total use of detergent and reduces water consumption therefore saving energy.

- 1** Detergent dispenser drawer
- 2** Control panel
- 3** Door opening handle
- 4** Rating plate
- 5** Drain pump
- 6** Adjustable feet

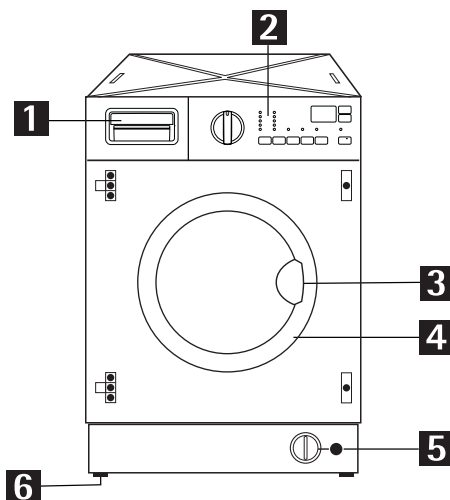

Detergent dispenser drawer

- I** Compartment for detergent used for prewash. The prewash detergent is added at the beginning of the wash programme.
- II** Compartment for powder or liquid detergent used for main wash.
-  Compartment for liquid additives (fabric softener, starch)

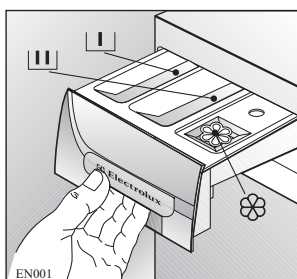

Control panel



Below is a picture of the control panel. It shows the programme selector dial as well as the buttons, pilot lights and the display. These are presented by relevant numbers on the following pages.

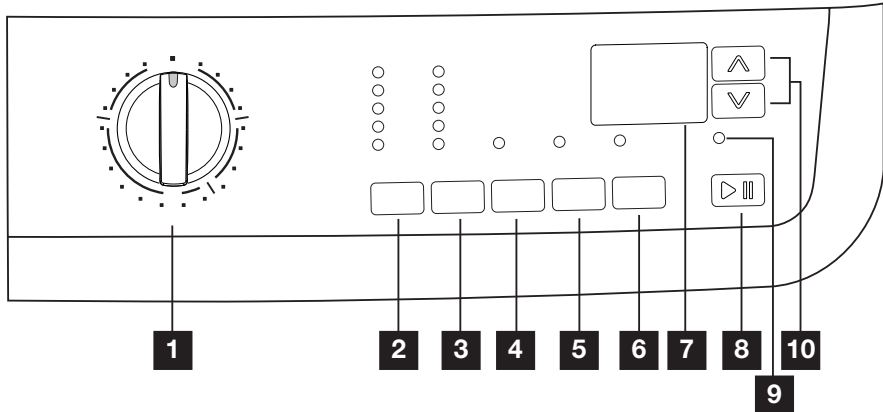

1 Programme selector dial

2 Temperature button

3 Spin reduction button

4 Extra Rinse button

5 Drying Time button

6 Delay Start button

7 Display

8 Start/Pause button

9 Door locked pilot light

10 Time Manager buttons

Display (7)

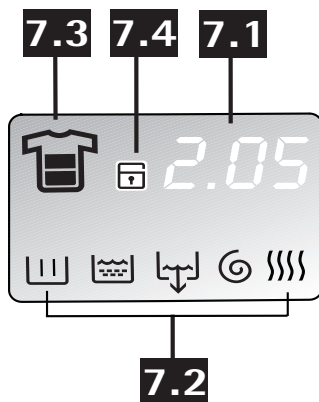

7.1 Duration of selected programme/

After selecting a programme, the duration is displayed in hours and minutes (for example *2.05*). The duration is calculated automatically on the basis of the maximum recommended load for each type of fabric. After the programme has started, the time remaining is updated every minute.

/Selected drying time

After selecting a drying programme, the drying time is displayed in minutes or in hours and minutes (e.g 130 mins = *2.10*).

After the programme has started the time remaining is updated every minute.

/Delayed start

The selected delay set by pressing the relevant button appears on the display for a few seconds, then the duration of the previously selected programme is displayed.

/Alarm codes

In the event of operating problems, some alarm codes can be displayed, for example *E20* (see chapter «What to do if...»).

/Incorrect option selection

If an option which is not compatible with the set wash programme is selected, the message **Err** is displayed for a few seconds and the integrated red light of button **8** starts blinking.

/End of programme

When the programme has finished three blinking zeros *0.00* are displayed, the pilot light **9** and the pilot light of button **8** go out and the door can be opened.

7.2 Washing phase icons

By selecting the wash programme, the washing programme phase icons corresponding to the various phases making up the programme are shown in the bottom of the display.

 = washing

 = rinsing

 = draining

 = spinning

 = drying

After the machine has started, only the running icon stays on. When the programme has finished, the flashing zero (0.00) is displayed.

7.3 Soil level icons

When selecting a programme on the display appears an icon indicating the degree of soiling automatically proposed by the machine.

7.4 Child lock

This function allows you to leave the appliance unsupervised during its functioning.

Door locked light (9)

The pilot light **9** illuminates to indicate that the appliance starts operating and the door is locked.

This light indicates if the door can be opened:

- light on: the door cannot be opened.
- blinking: the door is opening.
- light off: the door can be opened.



If your laundry is not removed within 10 minutes after the programme is finished, the backlight of the display switches off and the energy saving system will be enabled.

Only the button **8** pilot light is blinking to indicate that the appliance has to be switched off.

By pressing any buttons the appliance will come out from the energy saving status and you could set another washing programme or switch off the appliance.

Use

First Use



- Ensure that the electrical and water connections comply with the installation instructions.
- Remove the polystyrene block and any material from the drum.
- Pour 2 litres of water into the main wash compartment **III** of the detergent drawer in order to activate the ECO valve. Pour 1/2 a measure of detergent into the dispenser drawer and start the machine. Then run a cotton cycle at 90°C, without any laundry in the machine, to remove any manufacturing residue from the drum and tub.

Acoustic signals

The machine is provided with an acoustic device, which sounds in the following cases:

- at the end of the cycle
- if there is a fault

By pressing buttons **4** and **5** simultaneously for about 6 seconds, the acoustic signal is deactivated (except if there is a fault).

By pressing these 2 buttons again, the the acoustic signal is reactivated.

Child safety lock

This function allows you to leave the appliance unsupervised and not to worry that children might be injured by or cause damage to the appliance.

This function remains able also when

the washing machine is not working. There are two different ways to set this option:

- 1** before pressing button **8**: it will be impossible to start the machine.
- 2** after pressing button **8**: it will be impossible to change any other programme or option.

To enable or disable this option press buttons **5** and **6** simultaneously for about 6 seconds until on the display, the icon  appears or disappears.

Daily Use



Load the laundry

Open the door by carefully pulling the door handle outwards. Place the laundry in the drum, one item at a time, shaking them out as much as possible. Close the door.

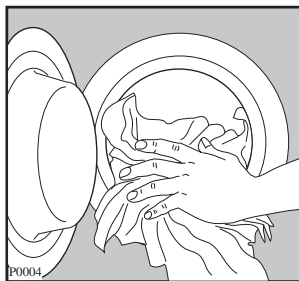

Measure out the detergent and the fabric softener

Pull out the dispenser drawer until it stops. Measure out the amount of detergent required, pour it into the main wash compartment **III** and, if you wish to carry out the **prewash**, pour it into the compartment marked **II**.

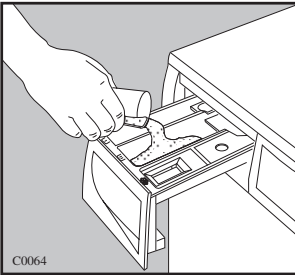

If required, pour fabric softener into the compartment marked  (the amount used must not exceed the "MAX" mark in the drawer). Close the drawer gently.

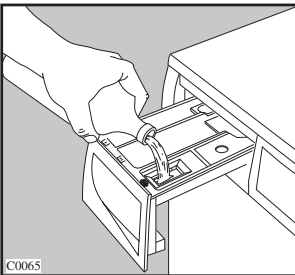

Select the required programme by turning the programme selector dial (1)

Turn the programme selector dial to the required programme. The light of button **8** starts to flash and the display shows the duration of the selected programme.

The selector dial can be turned either clockwise or anticlockwise. Turn to position  to Reset programme/ Switch OFF the machine.

For the description of each of the washing programmes on the selector dial, consult the chapter «Washing programmes».

At the end of the programme the selector dial must be turned to position , to switch the machine off.

Attention!

If you turn the programme selector dial to another programme when the machine is working, the **red** light of button **8** will blink 3 times and the message **Err** will appear on the display to indicate a wrong selection. The machine will not perform the new selected programme.

Programme Option buttons

Depending on the programme, different functions can be combined. These must be selected after choosing the desired programme and before pressing the button **8**.

When these buttons are pressed, the corresponding pilot lights illuminate. When they are pressed again, the pilot lights go out.

If an incorrect option is selected, the integrated red pilot light of the button **8** flashes 3 times and the **Err** message appears on the display for some seconds.

For the compatibility among the washing programmes and the options see chapter «Washing Programmes».

Select the temperature by pressing button **2**

Press this button repeatedly to increase or decrease the temperature, if you want your laundry to be washed at a temperature different from the one proposed by the washer-dryer.

Select the spin speed, Rinse Hold or No Spin option by pressing button **3**

Press button **3** repeatedly to change the spin speed, if you want your laundry to be spun at a speed different

from the one proposed by the washer-dryer. The relevant light will light up.

When you select a programme, the machine automatically proposes the maximum spin speed provided for the programme.

Rinse Hold: by selecting this option the water of the last rinse is not emptied out to prevent the fabrics from creasing. When the programme has finished the display shows **0.00** flashing, the pilot light **9** is on, the light of button **8** is off and the door is locked to indicate that the water must be emptied out.

To empty the water out, please read the chapter «At the end of the programme».

No spin : by selecting this option, all spinning phases are suppressed and replaced by a drain, so as not to wrinkle the laundry. Recommended for extremely delicate fabrics.

On some programmes the rinses will be performed with more water.

Select the Extra Rinse option by pressing button 4

The machine performs some additional rinses. This option is recommended for people who are allergic to detergents, and in areas where the water is very soft.

Select the Drying Time by pressing button 5

If you wish to carry out a timed drying programme, press this button until the drying time you want appears on the display according to the fabrics (cottons or synthetics) you have to dry. For **Cottons** you can select a drying time from 10 minutes to 250 minutes (**4.10**).

For **Synthetics** you can select a drying time from 10 minutes to 130 minutes (**2.10**).

Every time you press this button the drying time increases by 5 mins.

Select the Delay Start by pressing button 6

Before you start the programme, if you wish to delay the start, press button **6** repeatedly, to select the desired delay. The relevant light will illuminate.

The selected delay time value (up to 20 hours) will appear on the display for a few seconds, then the duration of the programme will appear again.

You must select this option after you have set the programme and before you press button **8**.

The door will be locked throughout the delay time. If you wish to add laundry in the machine during the delay time press button **8** to put the machine in pause and wait until the pilot light **9** goes out before opening the door. Add the laundry, close the door and press the button **8** again.

You can cancel or modify the delay time at any moment, before you press button **8**.

The wash programme can be delayed from 30 min - 60 min - 90 min, 2 hours and then by 1 hour up to a maximum of 20 hours by means of this button.

Selecting the delayed start.

- Select the programme and the required options.
- Select the delay start.
- Press button **8**: the machine starts its hourly countdown.

The programme will start after the selected delay has expired.

Cancelling the delayed start after having started the machine

- Press button **8**.
- Press button **6** once until the symbol  is displayed.
- Press button **8** again.

The Delay Start **can not** be selected with **Drain** programme.

Select the Start/Pause by pressing button 8

To start the selected programme, press button **8**; the green pilot light stops flashing.

To interrupt a programme which is running, press button **8**: the green pilot light starts to flash.

To restart the programme from the point at which it was interrupted, **press** button **8** again.

If you have chosen a delayed start, the machine will begin the countdown.







If an incorrect option is selected, an integrated **red** pilot light of button **8** flashes 3 times the message **Err** is displayed for a few seconds.

Select the Time Manager option by pressing buttons 10

This function allows you to modify the washing time, automatically proposed by the washer-dryer.

By pressing this button repeatedly, the duration of the washing cycle can be increased or decreased.

A soil level icon will appear on the display to indicate the chosen degree of soiling.

Soil Level	Icon	Type of fabric
Intensive		For heavy soiled items
Normal		For normal soiled items
Daily		For daily soiled items
Light		For slightly soiled items
Quick		For very slightly soiled items
Super Quick (*)		For items used or worn for a short time







(*) We recommend that you reduce the load sizes (see «Washing programmes»).

Attention!



This option cannot be selected with the **Economy** cottons programmes.

The availability of these soil level icons change according to the type of fabric as shown in the following chart:

Fabric	Soil Level					
	Intensive	Normal	Daily	Light	Quick	S. Quick
Cottons						
95°-90°C	X	X	X	X	X	X
60°C	X	X	X	X	X	X
50°C	X	X	X	X	X	X
40°C	X	X	X	X	X	X
30°C	X	X	X	X	X	X
Synthetics						
60°C		X	X	X		X
50°C		X	X	X		X
40°C		X	X	X		X
30°C		X	X	X		X
Delicates						
40°C		X	X	X		X
30°C		X	X	X		X

Altering an option or a running programme

It is possible to change some options before the programme carries it out. Before you make any change, you must pause the washer-dryer by pressing button **8**.

(Only the Time Manager option cannot be modified after the programme has started.)

Changing a running programme is possible **only by resetting it**. Turn the programme selector dial to **0** and then to the new programme position. Start the new programme by pressing button **8** again. The washing water in the tub will not be emptied out.

Interrupting a programme

Press button **8** to interrupt a programme which is running, the corresponding light starts to flash. Press the button again to restart the programme.

Cancelling a programme

Turn the selector dial to **0** to cancel a programme which is running. You can now select a new programme.

Opening the door after the programme has started

First set the machine to pause by pressing button **8**.

If the light **9** blinks and then goes off, the door can be opened.

If the light **9** remains lit, this means that the machine is already heating, that the water level is too high.

In this case the door can not be opened.

If you cannot open the door but you need to open it you have to switch the machine off by turning the selector dial

to **0**. After a few minutes the door can be opened (**pay attention to the water level and temperature!**).

After closing the door, it is necessary to select the programme and options again and press button **8**.

At the end of the programme

The machine stops automatically, the pilot light of button **8** goes off and three blinking «**0.00**» will appear on the display. The buzzer sounds.

If a programme with an option that ends with water still in the tub has been selected, the pilot light **9** remains lit and the door is locked to indicate that the water must be emptied out before opening the door.

To empty out the water:

- turn the programme selector dial to **0**
- select the Drain or the Spin programme
- reduce the spin speed if needed, by pressing the relevant button
- press button **8**

At the end of programme, the display shows 3 flashing zeros «**0.00**». the pilot lights **9** goes off and the door can be opened.

Turn the programme selector dial to **0** to switch the machine off.

Remove the laundry from the drum and carefully check that the drum is empty.

If you do not intend to carry out another wash, close the water tap. Leave the door open to prevent the formation of mildew and unpleasant smells.



Use - Drying



DRYING ONLY

The recommended loads size is 3 kg for cottons and linen, and 2 kg for synthetics. **Note! It is also possible to dry up to 4 kg of cotton items (see the drying time table).**

The water tap must be open and the drain hose must be positioned in the sink or connected to the drain pipe.

1. Load the laundry.
2. Select the drying programme (for Cottons  or Synthetics  in the **Drying**  sector).
3. If you wish to select a **timed drying**, press button **5** until the time you want appears on the display (see the drying programmes). Every time you press this button the drying time increases by 5 mins.

Note!

The programme time will automatically increase by some minutes, this is quite normal.

4. Press button **8** to start the programme.

After the programme has started, the time remaining is updated every minute.

Note!

The different type of cottons (towelling, sheets, shirts, and so on) or any laundry items rolling up during the spinning phase may result in partial dryness. In the exceptional case that at

the end of the cycle the laundry remains slightly wet, we suggest that you unfold the rolled up items, redistribute them evenly in the drum and select an additional drying cycle of 20-30 minutes.

5. At the end of the programme, the buzzer sounds and three blinking «0.00» appear on the display. The pilot light **9** is on to indicate that the door is locked.

The last 10 minutes of the drying cycle correspond to an anti-crease phase. During this time the door is locked and the display keeps showing three flashing zeros «0.00»

Note!

If you wish to open the door before or during the anti-crease phase or to interrupt it, press any button or turn the programme selector dial to any programme position (except , the door can be opened after some minutes (pilot light **9** is off).

6. Turn the selector dial to the  position to switch the machine off. Remove the laundry.

Automatic washing and drying (NON-STOP programme)

For NON-STOP programmes, the recommended load size is 3 kg for cotton and 2 kg for synthetics.

Note! It is also possible also to dry up to 4 kg of cotton items (see the drying time table).

Do not use a dosing device/ball when carrying out a washing & drying programme.

18 electrolux **drying**

1. Load the laundry.
2. Add detergent and fabric softener.
3. Switch the machine on by turning the selector dial to the selected washing programme/fabric.
4. Select the required options by pressing the relevant buttons.

Note!

If possible, do not select a spin speed lower than that proposed by the appliance to avoid too long a drying time therefore saving energy.

In any case the reduction of the spin speed is only possible after selecting drying.

The lowest values you can select are the following:

- 900 r.p.m. for cottons and 700 r.p.m. for synthetics with timed drying

5. Select the drying time by pressing button **5**. The display shows the entire duration of the washing and the selected drying cycle.
6. Start the programme by pressing button **8**. After the programme has started, the time remaining is updated every minute.
7. At the end of the programme turn the selector dial to the **0** position to switch the machine off.
8. Remove the laundry.

Washing and Drying hints



Sorting the laundry

Follow the wash code symbols on each garment label and the manufacturer's washing instructions. Sort the laundry as follows: whites, coloureds, synthetics, delicates, woollens.

Temperatures

90°/95°	for normally soiled white cottons and linen (e.g. tea cloths, towels, tablecloths, sheets...)
50°/60°	for normally soiled, colour fast garments (e.g. shirts, night dresses, pyjamas....) in linen, cotton or synthetic fibres and for lightly soiled white cotton (e.g. underwear).
30° - 40°	for delicate items (e.g. net curtains), mixed laundry including synthetic fibres and woollens bearing the label «pure new wool, machine washable, non-shrink».

Before loading the laundry

Never wash whites and coloureds together. Whites may lose their "whiteness" in the wash.

New coloured items may run in the first wash; they should therefore be washed separately the first time.

Make sure that no metal objects are left in the laundry (e.g. hair clips, safety pins, pins).

Button up pillowcases, close zip fasteners, hooks and poppers. Tie any belts or long tapes.

Remove persistent stains before washing.

Rub particularly soiled areas with a special detergent or detergent paste.

Treat curtains with special care.

Remove hooks or tie them up in a bag or net.

Avoid drying dark clothes with light coloured fluffy items such as towels as these can attract the fluff.

Remove the laundry when the appliance has finished drying.

To avoid a static charge when drying is completed, use either a fabric softener when you are washing the laundry or a fabric conditioner specifically for tumble dryers.

Particularly delicate items such as synthetic curtains, woollen and silk, garments with metal inserts, nylon stockings, bulky garments such as anoraks, bedcovers, quilts, sleeping bags and duvets must not be machine dried.

Garments padded with foam-rubber or materials similar to foam-rubber must not be machine dried; they represent a fire hazard.

Also, fabrics containing residues of setting lotions or hair sprays, nail solvents or similar solutions must not be machine dried in order to avoid the formation of harmful vapours.

For drying, follow the indications given on the manufacturer's labels.

- May be tumble dried
- Drying at high temperature
- Drying at reduced temperature
- Do not tumble dry

Important

As a dryer, the machine works on the condensation principle.

Therefore, the water tap must be open and the drain hose must drain water into a sink or into the drain pipe, even during the drying cycle.

Maximum loads

Recommended loads are indicated in the programme charts.

General rules:

Cotton, linen: drum full but not too tightly packed;

Synthetics: drum no more than half full;

Delicate fabrics and woollens: drum no more than one third full.

Washing a maximum load makes the most efficient use of water and energy.

For heavily soiled laundry, reduce the load size.

Laundry weights

The following weights are indicative:

bathrobe	1200 g
napkin	100 g
quilt cover	700 g
sheet	500 g
pillow case	200 g
tablecloth	250 g
towelling towel	200 g
tea cloth	100 g
night dress	200 g
ladies' briefs	100 g
man's work shirt	600 g
man's shirt	200 g
man's pyjamas	500 g
blouse	100 g
men's underpants	100 g

Removing stains

Stubborn stains may not be removed by just water and detergent. It is therefore advisable to treat them prior to washing.

Blood: treat fresh stains with cold water. For dried stains, soak overnight in water with a special detergent then rub in the soap and water.

Oil based paint: moisten with benzine stain remover, lay the garment on a soft cloth and dab the stain; treat several times.

Dried grease stains: moisten with turpentine, lay the garment on a soft surface and dab the stain with the fingertips and a cotton cloth.

Rust: oxalic acid dissolved in hot water or a rust removing product used cold. Be careful with rust stains which are not recent since the cellulose structure will have already been damaged and the fabric tends to hole.

Mould stains: treat with bleach, rinse well (whites and fast coloureds only).

Grass: soap lightly and treat with bleach (whites and fast coloureds only).

Ball point pen and glue: moisten with acetone (*), lay the garment on a soft cloth and dab the stain.

Lipstick: moisten with acetone as above, then treat stains with methylated spirits. Remove any residual marks from white fabrics with bleach.

Red wine: soak in water and detergent, rinse and treat with acetic or citric acid, then rinse. Treat any residual marks with bleach.

Ink: depending on the type of ink, moisten the fabric first with acetone (*), then with acetic acid; treat any residual marks on white fabrics with bleach and then rinse thoroughly.

Tar stains: first treat with stain remover, methylated spirits or benzine, then rub with detergent paste.

(*) do not use acetone on artificial silk.

Detergents and additives

Good washing results also depend on the choice of detergent and use of the correct quantities to avoid waste and protect the environment. Although biodegradable, detergents contain substances which, in large quantities, can upset the delicate balance of nature.

The choice of detergent will depend on the type of fabric (delicates, woollens, cottons, etc.), the colour, washing temperature and degree of soiling.

All commonly available washer-dryer detergents may be used in this appliance:

- powder detergents for all types of fabric,
- powder detergents for delicate fabrics (60°C max) and woollens,
- liquid detergents, preferably for low temperature wash programmes (60°C max) for all types of fabric, or special for woollens only.

The detergent and any additives must be placed in the appropriate compartments of the dispenser drawer before starting the wash programme.

If using concentrated powder or liquid detergents, a programme **without** prewash must be selected.

Pour liquid detergent into the dispenser drawer compartment marked  **just before** starting the programme.

Any fabric softener or starching additives must be poured into the compartment marked  before starting the wash programme.

Follow the product manufacturer's recommendations on quantities to use and **do not exceed the «MAX» mark in the detergent dispenser drawer.**

Quantity of detergent to be used

The type and quantity of detergent will depend on the type of fabric, load size, degree of soiling and hardness of the water used.

Water hardness is classified in so-called "degrees" of hardness.

Information on hardness of the water in your area can be obtained from the relevant water supply company, or from your local authority.

Follow the product manufacturers' instructions on quantities to use.

Use less detergent if:

- you are washing a small load,
- the laundry is lightly soiled,
- large amounts of foam form during washing.

Degrees of water hardness

Level	Characteristic	Degrees	
		German °dH	French °T.H.
1	soft	0-7	0-15
2	medium	8-14	16-25
3	hard	15-21	26-37
4	very hard	> 21	> 37

Preparing the drying cycle

As a dryer, the machine works on the condensation principle.

Therefore, the water tap must be open and the drain hose must drain water into a sink or into the drain pipe, even during the drying cycle.

Attention!

Before starting the drying programme, reduce the loads of washed laundry, in order to obtain good performances.

Laundry not suitable for drying

- Particularly delicate items such as synthetic curtains, woollen and silk, garments with metal inserts, nylon stockings, bulky garments such as anoraks, bedcovers, quilts, sleeping bags and duvets must not be machine dried.
- Avoid drying dark clothes with light coloured fluffy items such as towels as these can attract the fluff.
- Remove the laundry when the appliance has finished drying.
- To avoid a static charge when drying is completed, use either a fabric softener when you are washing the laundry or a fabric conditioner specifically for tumble dryers.
- Garments padded with foam-rubber or materials similar to foam-rubber must not be machine dried; they represent a fire hazard.
- Also, fabrics containing residues of setting lotions or hair sprays, nail solvents or similar solutions must not be machine dried in order to avoid the formation of harmful vapours.

Garment labels

For drying, follow the indications given on the manufacturer's labels:

- May be tumble dried
- Drying at high temperature
- Drying at reduced temperature
- Do not tumble dry.

Drying cycle duration

The drying time may vary depending on:

- speed of the final spin
- dryness degree required (iron dry, store dry)
- type of laundry
- weight of the load size

The average drying time for a timed drying are indicated in the «Drying programmes» chapter. The experience will help you to dry your laundry in a more suitable way, according to the different fabrics. Take note of the duration drying time of the already performed cycles.

Additional drying

If the laundry is still damp at the end of the drying programme, select a short drying cycle again.

Attention! Do not over dry the laundry in order to avoid creasing of fabrics or garment's shrinking .

Washing programmes

Programme/ Temperature	Type of laundry	Options	Description of programme
Cottons 90° - 30°	White and coloured cotton (normally soiled items)	SPIN REDUCTION/NO SPIN/RINSE HOLD, EXTRA RINSE, TIME MANAGER*	Main wash Rinses Long spin Max. load kg 6 * Red. load kg 3
Cottons + Prewash 90° - 30°	White and coloured cotton (heavily soiled items)	SPIN REDUCTION/NO SPIN/RINSE HOLD, EXTRA RINSE, TIME MANAGER*	Prewash/Main wash Rinses Long spin Max. load kg 6 * Red. load kg 3
Synthetics 60° - 30°	Synthetic or mixed fabrics (normally soiled items)	SPIN REDUCTION/NO SPIN/RINSE HOLD, EXTRA RINSE, TIME MANAGER*	Main wash Rinses Short spin Max. load kg 3 * Red. load kg 1,5
Delicates 40° - 30°	Delicate fabrics	NO SPIN/RINSE HOLD, EXTRA RINSE TIME MANAGER*	Main wash Rinses Short spin Max. load kg 3 * Red. load kg 1,5
Easy Iron 60° - 30°	Synthetic or mixed fabrics to be ironed	SPIN REDUCTION/NO SPIN/RINSE HOLD, EXTRA RINSE	Main wash Rinses Short spin Max. load kg 1
Spin	Separate spin for cottons	SPIN REDUCTION	Drain and long spin Max. load kg 6

* If you select the SUPER QUICK option by pressing Time Manager buttons (10), we recommend that you reduce the maximum load as indicated. (Red. load = reduced load). Full loading is possible however with somewhat reduced cleaning results.



Washing programmes

Programme/ Temperature	Type of laundry	Options	Description of programme
Drain	For emptying out the last rinse water in programmes with the Rinse Hold option		Draining of water
Rinses	Separate rinse cycle for cotton hand washed items	SPIN REDUCTION/No SPIN/RINSE HOLD EXTRA RINSE	Rinses Long spin Max. load kg 6
Silk 30°	Silk items to be gently washed and spun	No SPIN/ RINSE HOLD	Main wash Rinses Short spin Max. load kg 1
Handwash 40° - 30°	Special programme for hand washing fabrics	SPIN REDUCTION/No SPIN/RINSE HOLD	Main wash Rinses Short spin Max. load kg 2
Wool 40° - 30°	Specially tested programme for wool garments bearing the "Pure new wool, non-shrink, machine washable" label	SPIN REDUCTION/No SPIN/RINSE HOLD	Main wash Rinses Short spin Max. load kg 2
Cottons Economy 90° - 40°	White and coloured cotton economy , lightly soiled	SPIN REDUCTION/No SPIN/RINSE HOLD, EXTRA RINSE	Main wash Rinses Long spin Max. load kg 6
O	For cancelling the wash programme which is running and to switch the machine off		

Programme information



Wool and Handwash

Washing programme for machine washable wool  as well as for hand washable woollens and delicate fabrics with the “hand washing” care symbol .

Note: A single or bulky item may cause imbalance. If the appliance doesn't perform the final spin phase, add more items, redistribute the load manually and then select the spinning programme.

Silk

Delicate washing programme suitable for silk and mixed synthetic items. Washing temperature is maximum 30°C. The maximum spin speed is automatically reduced.

Economy

This programme can be selected for slightly or normally soiled cotton items. The temperature will decrease and the washing time will be extended. This allows you to obtain a good washing efficiency whilst saving energy.

Rinses

With this programme it is possible to rinse and spin cotton garments which have been washed by hand. The machine performs 3 rinses, followed by a final long spin at maximum speed. The spin speed can be reduced by pressing button **3**.

Drain

For emptying out the water of the last rinse in programmes with the Rinse Hold option. Firstly turn the programme selector dial to **0**, then select the Drain programme and press button **8**.

Spin

Separate spin for hand washed garments and after programmes with Rinse Hold or No Spin option. Before selecting this programme the selector dial must be turned to **0**. You can choose the speed by pressing the relevant button to adapt it to the fabrics to be spun.

0 = Cancelling/OFF

To reset a programme and to switch off the machine turn the selector dial to **0**. A new programme can now be selected.

Drying Time



Degree of drying	Type of fabric	Max load	Spin Speed	Suggested drying time in mins
Suitable for items to put away without ironing	Cotton and linen (bathrobes, bath towels, etc)	4 kg	1400	150 - 170
		3 kg	1400	100 - 110
		1.5 kg	1400	65 - 75
	Synthetics and mixed fabrics	2 kg	900	100 - 110
		1 kg	900	60 - 70
Suitable for ironing	Cotton and linen (sheets, tablecloths, shirts, etc.)	4 kg	1400	120 - 140
		3 kg	1400	80 - 90
		1.5 kg	1400	50 - 60

In compliance with EC directive EN 50229 the cotton reference programme for the data entered in the Energy Label must be tested dividing the maximum washing load by two equal parts and drying with DRYING TIME each of them.

Care and cleaning



You must **DISCONNECT** the appliance from the electricity supply, before you can carry out any cleaning or maintenance work.

Descaling

The water we use normally contains lime. It is a good idea to periodically use a water softening powder in the machine. Do this separately from any laundry washing, and according to the softening powder manufacturer's instructions. This will help to prevent the formation of lime deposits.

After each wash

Leave the door open for a while. This helps to prevent mould and stagnant smells forming inside the appliance. Keeping the door open after a wash will also help to preserve the door seal.

Maintenance Wash

With the use of low temperature washes it is possible to get a build up of residues inside the drum. We recommend that a maintenance wash be performed on a regular basis.

To run a maintenance wash:

- The drum should be empty of laundry.
- Select the hottest cotton wash programme.
- Use a normal measure of detergent, must be a powder with biological properties.

External cleaning

Clean the exterior cabinet of the appliance with soap and water only, and then dry thoroughly.

Cleaning the dispenser drawer

The washing powder and additive dispenser drawer should be cleaned regularly.

Remove the drawer by pressing the catch downwards and by pulling it out. Flush it out under a tap, to remove any traces of accumulated powder.

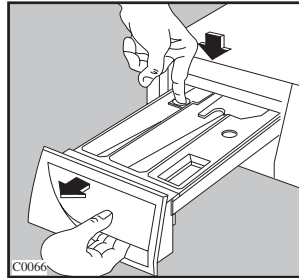

To aid cleaning, the top part of the additive compartment should be removed. Clean all parts with water.

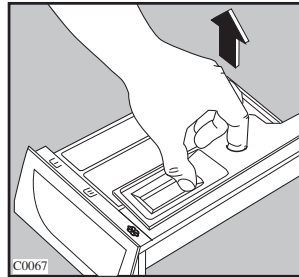

Cleaning the drawer recess

Having removed the drawer, use a small brush to clean the recess, ensuring that all washing powder residue is removed from the upper and lower part of the recess.

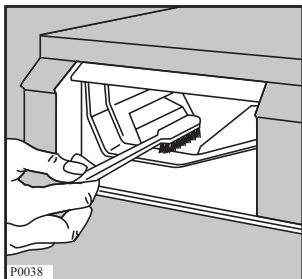

Insert the detergent dispenser drawer in the guide rails and push it in.

Washing drum

Rust deposits in the drum may occur due to rusting foreign bodies in the washing or tap water containing iron.

Important! Do not clean the drum with acidic descaling agents, scouring agents containing chlorine or iron or steel wool.

1. Remove any rust deposits on the drum with a cleaning agent for stainless steel.
2. Run a washing cycle without any laundry to clean off any cleaning agent residues. Programme: COTTONS/LINEN 90° or 95°C, press button 10 to select Super Quick option, add approx. 1/4 measuring cup of detergent.

Door seal

Check the door seal from time to time and remove any objects that could be trapped in the fold.

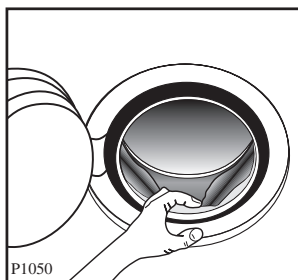

Cleaning the pump

The pump should be inspected if

- the machine does not empty and/or spin
- the machine makes an unusual noise during draining due to objects such as safety pins, coins etc. blocking the pump.

Proceed as follows:

- Disconnect the appliance.
- If necessary wait until the water has cooled down.

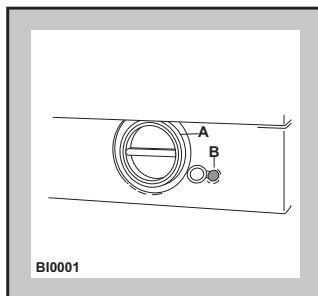

- Place a container close to the pump to collect any spillage.

- Pull out the emergency emptying hose (B), place it in the container and remove its cap.

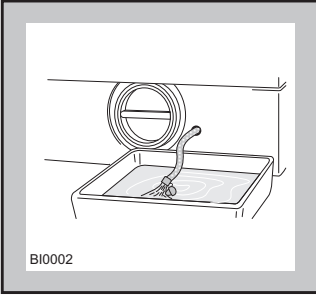

- When no more water comes out, unscrew the pump cover (A) and remove it. Always keep a rag nearby to dry up spillage of water when removing the cover.

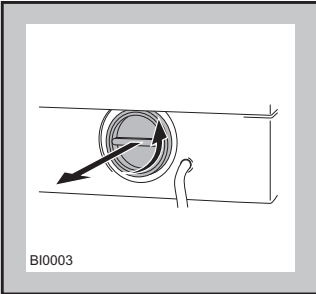

- Remove any objects from the pump impeller by rotating it.

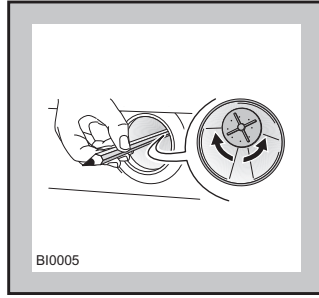
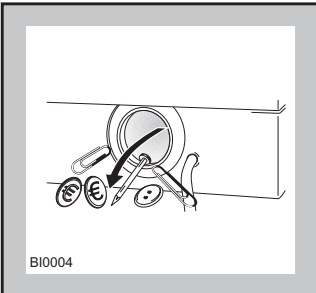

- Put the cap back on the emergency emptying hose and place the latter back in its seat.
- Screw the pump cover fully in.

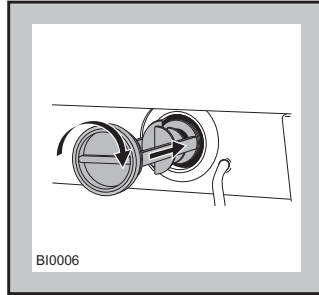

Warning!



When the appliance is in use and depending on the programme selected there can be hot water in the pump. Never remove the pump cover during a wash cycle, always wait until the appliance has finished the cycle, and is empty. When replacing the cover, ensure it is securely retightened so as to stop leaks and young children being able to remove it.

Cleaning the water inlet filter

If your water is very hard or contains traces of lime deposit, the water inlet filter may become clogged. It is therefore a good idea to clean it from time to time.

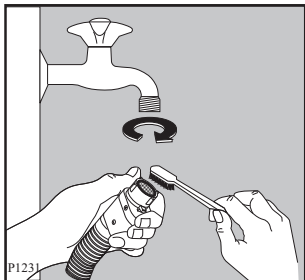

Turn off the water tap. Unscrew the water inlet hose. Clean the filter using a hard bristle brush. Refit the inlet hose.

The dangers of freezing

If the machine is exposed to temperatures below 0°C, certain precautions should be taken.

- Turn off the water tap.
- Unscrew the inlet hose.
- Place the end of the emergency emptying hose and that of the inlet hose in a bowl placed on the floor and let water drain out.
- Screw the water inlet hose back on and reposition the emergency emptying hose after having put the cap on again.
- When you intend to start the machine up again, make sure that the room temperature is above 0°C.

Emergency emptying out

If the water is not discharged, proceed as follows to empty out the machine:

- pull out the plug from the power socket;
- close the water tap;
- if necessary, wait until the water has cooled down;
- place a bowl on the floor and place the end of the emergency emptying hose into the bowl. Remove its cap. The water should drain by gravity into the bowl. When the bowl is full, put the cap back on the hose. Empty the bowl. Repeat the procedure until water stops flowing out;
- clean the pump if necessary as previously described;
- replace the emergency emptying hose in its seat after having plugged it;
- screw the pump cover again.



Important!

Every time you drain the water through the emergency emptying hose you must pour 2 litres of water into the main wash compartment of the detergent drawer and then run the drain programme. This will activate the ECO VALVE device.

What to do if...

Certain problems are due to lack of simple maintenance or oversights, which can be solved easily without calling out an engineer. Before contacting your local Service Centre, please carry out the checks listed below.

During machine operation it is possible that the **red** light of button **8** blinks, at the same time some acoustic signals sound and one of the following alarm codes appears on the display to indicate that the machine is not working:

- **E10**: problem with the water supply
- **E20**: problem with water draining
- **E40**: door open.

Once the problem has been eliminated, press button **8** to restart the programme. If after all checks, the problem persists, contact your local Service Centre.

Malfunction	Possible cause	Solution
<p>The washer-dryer does not start:</p>	<ul style="list-style-type: none"> ● The door has not been closed. <i>E40</i>. ● The plug is not properly inserted in the power socket. ● There is no power at the socket. ● The main fuse or the fuse in the plug has blown. ● The selector dial is not correctly positioned and button 8 has not been pressed. ● The delay start has been selected. ● The Child Safety Lock has been activated. 	<ul style="list-style-type: none"> ● Close the door firmly. ● Insert the plug into the power socket. ● Please check your domestic electrical installation. ● Replace the fuse. ● Please turn the selector dial and press button 8 again. ● If the laundry are to be washed immediately, cancel the delay start. ● Deactivate the Child Safety Lock.
<p>The machine does not fill:</p>	<ul style="list-style-type: none"> ● The water tap is closed. <i>E10</i> ● The inlet hose is squashed or kinked. <i>E10</i> ● The filter in the inlet hose is blocked. <i>E10</i> ● The door is not properly closed. <i>E40</i> 	<ul style="list-style-type: none"> ● Open the water tap. ● Check the inlet hose connection. ● Clean the water inlet hose filter. ● Close the door firmly.

Malfunction	Possible cause	Solution
The machine fills then empties immediately:	<ul style="list-style-type: none"> • The end of the drain hose is too low. 	<ul style="list-style-type: none"> • Refer to relevant paragraph in “water drainage” section.
The machine does not empty and/or does not spin:	<ul style="list-style-type: none"> • The drain hose is squashed or kinked. <i>E20</i> • The drain pump is clogged. <i>E20</i> • The Rinse Hold or No Spin option has been selected. • The laundry is not evenly distributed in the drum. 	<ul style="list-style-type: none"> • Check the drain hose connection. • Clean the drain pump. • Select the Drain or Spin programme. • Redistribute the laundry.
There is water on the floor:	<ul style="list-style-type: none"> • Too much detergent or unsuitable detergent (creates too much foam) has been used. • Check whether there are any leaks from one of the inlet hose fittings. It is not always easy to see this as the water runs down the hose; check to see if it is damp. • The drain or inlet hose is damaged. • The cap on the emergency emptying hose has not been replaced after cleaning the pump. 	<ul style="list-style-type: none"> • Reduce the detergent quantity or use another one. • Check the water inlet hose connection. • Replace it with a new one. • Put the cap back on the emergency emptying hose and place the latter back in its seat.
Unsatisfactory washing results:	<ul style="list-style-type: none"> • Too little detergent or unsuitable detergent has been used. • Stubborn stains have not been treated prior to washing. • The correct temperature was not selected. • Excessive laundry load. 	<ul style="list-style-type: none"> • Increase the detergent quantity or use another one. • Use commercial products to treat the stubborn stains. • Check if you have selected the correct temperature. • Reduce the laundry load.

Malfunction	Possible cause	Solution
<p>The door will not open:</p>	<ul style="list-style-type: none"> ● The programme is still running. ● The door lock has not been released. ● There is water in the drum. 	<ul style="list-style-type: none"> ● Wait until the end of washing cycle. ● Wait until the pilot light 9 goes off. ● Select drain or spin programme to empty out the water.
<p>The machine vibrates or is noisy:</p>	<ul style="list-style-type: none"> ● The transit bolts and packing have not been removed. ● The support feet have not been adjusted. ● The laundry is not evenly distributed in the drum. ● Maybe there is very little laundry in the drum. 	<ul style="list-style-type: none"> ● Check the correct installation of the appliance. ● Check the correct levelling of the appliance. ● Redistribute the laundry. ● Load more laundry.
<p>Spinning starts late or the machine does not spin:</p>	<ul style="list-style-type: none"> ● The electronic unbalance detection device has cut in because the laundry is not evenly distributed in the drum. The laundry is redistributed by reverse rotation of the drum. This may happen several times before the unbalance disappears and normal spinning can resume. If, after 10 minutes, the laundry is still not evenly distributed in the drum, the machine will not spin. In this case, redistribute the load manually and select the spin programme. ● The load is too small. 	<ul style="list-style-type: none"> ● Redistribute the laundry. ● Add more items, redistribute the load manually and then select the spinning programme.

Malfunction	Possible cause	Solution
The machine makes an unusual noise:	<ul style="list-style-type: none"> • The machine is fitted with a type of motor which makes a different noise compared with other traditional motors. This new motor ensures a softer start and more even distribution of the laundry in the drum when spinning, as well as increased stability of the machine. 	
No water is visible in the drum:	<ul style="list-style-type: none"> • Machines based on modern technology operate very economically using very little water without affecting performance. 	
No water is visible in the drum:	<ul style="list-style-type: none"> • The drying time has not been selected. • The water tap is not turned on. (E10) • The drain filter is clogged. (E20) • The machine is overloaded. • The selected drying time was not suitable for the laundry. 	<ul style="list-style-type: none"> • Select the drying time. • Open the water tap. • Clean the drain filter. • Reduce the laundry load. • Select the suitable drying time for the laundry.

If you are unable to identify or solve the problem, contact our service centre. Before telephoning, make a note of the model, serial number and purchase date of your machine: the Service Centre will require this information.

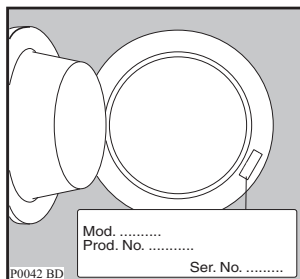

Technical data

Dimensions	Width	60 cm
	Height	82 cm
	Depth	54 cm
Electrical connection Voltage - Overall power - Fuse	Information on the electrical connection is given on the rating plate on the inner edge of the appliance door	
Water supply pressure	Minimum	0,05 MPa
	Maximum	0,8 MPa
Maximum Load	Cotton	6 kg
Maximum Dry Load	Cotton	3 kg
	Cotton Big capacity	4 kg
	Synthetics	2 kg
Spin Speed	Maximum	1400 rpm



Consumption values			
Programme	Water consumption (in litres)	Energy consumption (in kWh)	Programme duration (hours/minutes)
Cottons 90°	57	2.1	For the duration of the programmes, please refer to the display on the control panel.
Cottons 60°	53	1.2	
Cottons Economy 60° (*)	45	1.02	
Synthetics 60°	44	0.9	
Delicates 40°	56	0.55	
Wool 40°	58	0.45	

The consumption data shown on this chart is to be considered purely indicative, as it may vary depending on the quantity and type of laundry, on the inlet water temperature and on the ambient temperature. It refers to the highest temperature for each wash

programme.

(*) The programme «Cottons Economy» at 60°C with 6 kg of laundry is the reference programme for the data entered in the energy label, in compliance with EEC 92/75 standards.

Installation

Unpacking



All transit bolts and packing must be removed before using the appliance.

You are advised to keep all transit devices so that they can be refitted if the machine ever has to be transported again.

1. After removing all the packaging, carefully lay machine on it's back to remove the polystyrene base from the bottom.

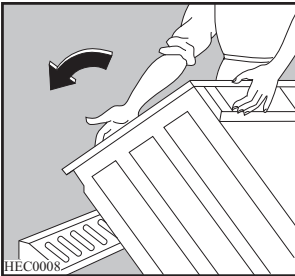

2. Remove the power supply cable and the draining hose from the hose holders on the rear of the appliance.

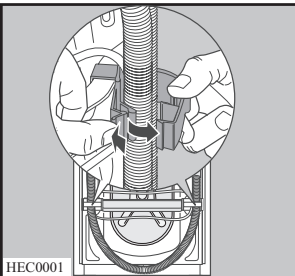

3. With the supplied spanner unscrew and remove the central rear bolt **A**. Slide out the relevant plastic spacer.

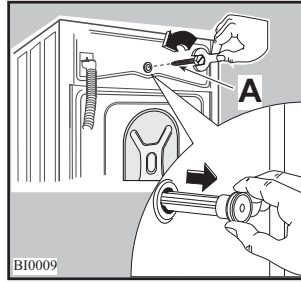

4. Unscrew and remove the two large rear bolts **B** and the six smaller bolts **C**.

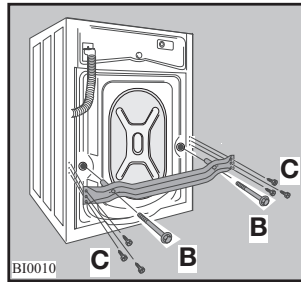

5. Remove the bracket **D** and refit the six smaller bolts **C**.

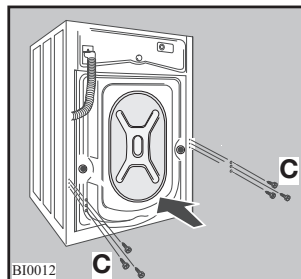
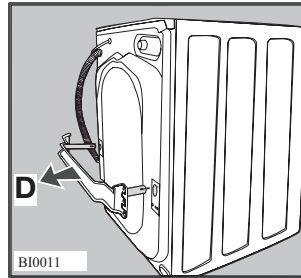

6. Fill the smaller upper hole and the two large ones with the corresponding plastic plug caps supplied in the bag containing the instruction booklet that you will find inside the drum.

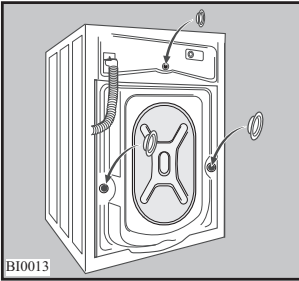

levelled the machine, tighten the lock nuts.

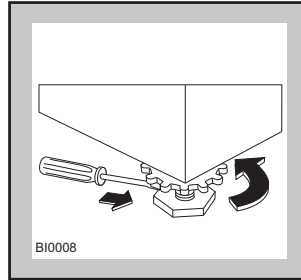

Positioning

Install the machine on a flat hard floor. Make sure that air circulation around the machine is not impeded by carpets, rugs etc. Check that the machine does not touch the wall or other kitchen units. Carefully level by screwing the adjustable feet in or out. The machine **MUST** be level and stable. If necessary, check the setting with a spirit level.

Any necessary adjustment can be made with a spanner.

Water inlet

An inlet hose is supplied and can be found inside the machine drum. Do not use the hose from your previous machine to connect to the water supply.

1. Open the porthole and extract the inlet hose.
2. Connect the hose with the angled connection to the machine.



Do not place the inlet hose downwards. Angle the hose to the left or right depending on the position of your water tap.

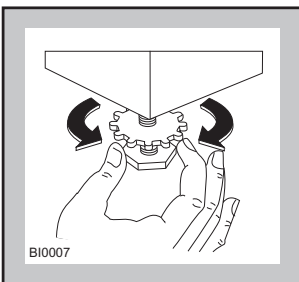

Accurate levelling prevents vibration, noise and displacement of the machine during operation. Never place cardboard, wood or similar materials under the machine to compensate for any unevenness in the floor. After having

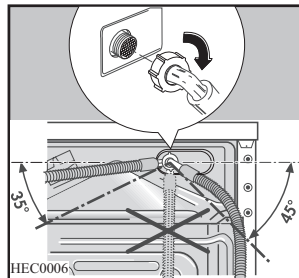

- Set the hose correctly by loosening the ring nut.

After positioning the inlet hose, be sure to tighten the ring nut again to prevent leaks.

- Connect the hose to a tap with a 3/4" thread. Always use the hose supplied with the appliance.

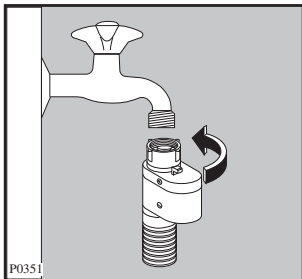

The inlet hose must not be lengthened. If it is too short and you do not wish to move the tap, you will have to purchase a new, longer hose specially designed for this type of use.

Water-stop device

The inlet hose is provided with a water stop device, which protects against damage caused by water leaks in the hose which could develop due to natural ageing of the hose. This fault is shown by a red sector in the window «A». Should this occur, turn the water tap off and refer to your Service Centre to replace the hose.

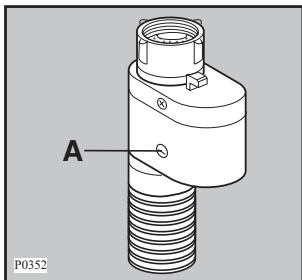

Note !
Installation should comply with local water authority and building regulations' requirements.

The appliance must be connected to a cold water supply.

A minimum water pressure of 0.05 MPa (0.5 bar) is required for safe operation of the appliance.

If you cannot make the cold water connection direct from the rising mains, you may be able to operate the appliance from your cold water storage system.

There should be a minimum vertical distance of 5.02m (16.5 ft) between the appliance's inlet and the bottom of the water storage tank.

Water drainage

This appliance is designed to be permanently plumbed into your home's drainage system using one of the following methods.

1. Into a drainage standpipe

Firstly form a hook in the end of the drain hose using the "U" piece supplied.



Place the drain hose into your standpipe, which should have an internal diameter of approximately 38mm thus ensuring there is an air break between the drain hose and standpipe.

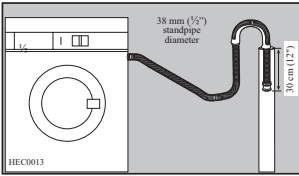

When discharging into a standpipe ensure that the top of the standpipe is no more than 90cm (35.4") and no less than 60cm (23.6") above floor level.

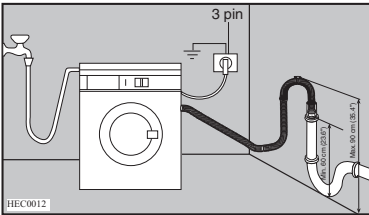

The drain hose may be extended to a maximum of 4 metres. An additional drain hose and joining piece is available from your local Service Force Centre. The joining piece must have an internal diameter of 18 mm.

If your drain hose looks like this (see below) you do not require the "U" piece". Just push the hose firmly into the standpipe.

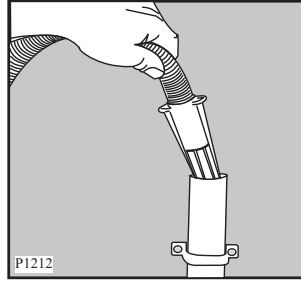

2. Onto a sink outlet spigot.

If the outlet spigot has not been used before, remove any blanking plug that may be in place.

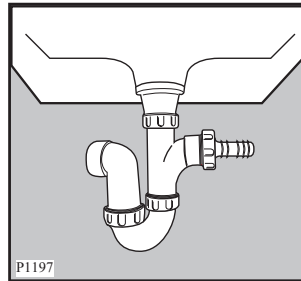

Push the drain hose onto the spigot and secure with a clip, ensure a loop is formed in the drain hose (see diagram) to prevent waste from the sink entering the washer-dryer.

The drain hose may be extended to a maximum of 4 metres. An additional drain hose and joining piece is available from your local Service Force Centre. The joining piece must have an internal diameter of 18 mm.

If you intend to drain the hose from the machine into a sink, make sure that the sink is empty and the plug hole is not blocked. Use the plastic “U -Piece” supplied.

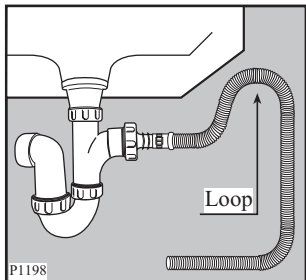

Important!

Before installing the machine to new pipework or to pipework that has not been used for some time, run off a reasonable amount of water to flush out any debris that may have collected in the pipes.

Special conditions

If the floor is carpeted or covered with crumbly or soft material, insert a rigid support base under the feet to prevent noise, vibration or displacement. The base should protrude a few centimetres beyond the edges of the machine.



Warning !

The machine should NOT be placed on deep pile carpeting.

Note

Please ensure that when the appliance

is installed it is easily accessible for the engineer in the event of a breakdown.

In the interest of the environment

Washer-dryers should be connected to the FOUL drainage system, the water will then be taken to a sewage works for treatment before being discharged safely into a river.

It is essential that these appliances are not connected to the surface water drainage system as this water is discharged directly into a river or stream and may cause pollution.

If you require any further advice please contact your local water authority.

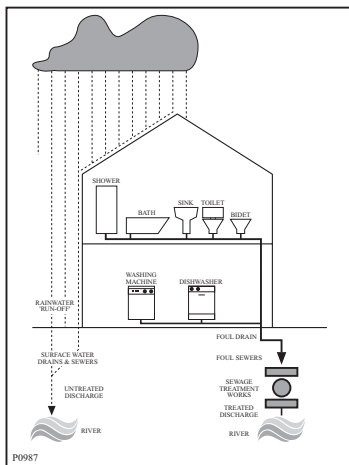

Electrical connection

Any electrical work required to install this appliance should be carried out by a qualified electrician or competent person.



Warning!

THIS APPLIANCE MUST BE EARTHED.

The manufacturer declines any liability should this safety measure not be observed.

Before switching on, make sure the electricity supply voltage is the same as that indicated on the appliance's rating plate.



Important!

Information on the electrical connection is given on the rating plate on the inner edge of the appliance door.

The appliance is supplied with a 13amp plug fitted.

In the event of having to change the fuse in the plug supplied, a 13amp ASTA approved (BS1363/A) fuse must be used.

Should the plug need to be replaced for any reason, proceed as described below.

The wires in the mains lead are coloured in accordance with the following code:

- Green and Yellow - Earth
- Blue - Neutral
- Brown - Live

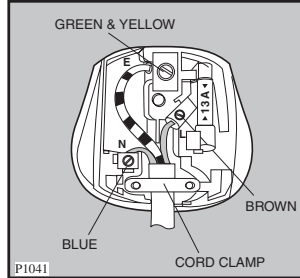

The wire coloured green and yellow must be connected to the terminal marked with the letter «E» or by the earth symbol \perp or coloured green and yellow.

The wire coloured blue must be connected to the terminal «N» or coloured black.

The wire coloured brown must be connected to the terminal marked «L» or coloured red.

Upon completion there must be no cut, or stray strands of wire present and the cord clamp must be secure over the outer sheath.



Warning!

A cut off plug inserted into a 13 amp socket is a serious safety (shock) hazard.

Ensure that the cut off plug is disposed of safely. Should the appli-

ance power supply cable need to be replaced, this must be carried out by our Service Force Centre.

Note

When the appliance is installed the power supply cable must be accessible.

Permanent connection

In the case of permanent connection it is necessary that you install a double pole switch between the appliance and the electricity supply (mains), with a minimum gap of 3mm between the switch contacts and of a type suitable for the required load in compliance with the current electrical regulations.

The switch must not break the yellow and green earth cable at any point.

Building-in

This appliance has been designed to be built into the kitchen furniture. The recess should have the dimensions shown in picture A.

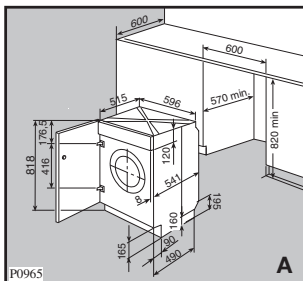

When installing the appliance into the kitchen furniture ensure, if possible, the hoses are placed in either of the two recesses on the back of the appliance.

This will help to prevent the hoses from becoming kinked or trapped.

Preparation and assembly of the door

The machine is originally pre-arranged for the assembly of a door opening from right to left.

In this case it is sufficient to screw in the hinges (1) and the counter-magnet (6) provided with the appliance, at the right level (Fig. B).

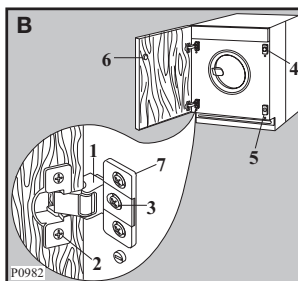

a) Door

The dimensions of the door should be:

- width 595-598 mm
- thickness 16-22 mm

The height (C-Fig. C) depends on the height of the adjacent furniture's base.

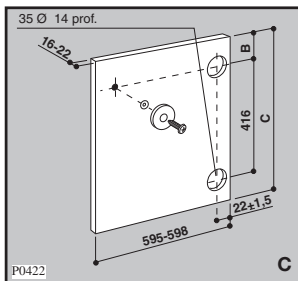

b) Hinges

To mount the hinges it is necessary to drill two holes (dia. 35 mm, depth 12.5-14 mm depending on the depth of door furniture) on the inner side of the door. The distance between the holes hobs fixing centres must be 416 mm.

The distance (B) from upper edge of the door to the centre of the hole depends on the adjacent furniture's dimensions.

The required dimensions are given in the picture C.

The hinges will be fixed to the door by means of screws for wood (2-Fig. B) supplied with the appliance.

c) Mounting the door

Fix the hinges (1) to the machine by means of the M5x15 screws (3-Fig. B). The hinges can be adjusted to compensate for possible uneven thickness of the door.

To align the door perfectly it is necessary to loosen the screw (3-Fig. B), adjust the door and tighten the screw again.

d) Counter-magnet (6)

The appliance is pre-arranged for a magnetic closure of the door. To enable a correct operation of this device, it is necessary to screw the counter-magnet (6) (steel disk + rubber ring) into the inner side of the door. Its position must correspond to the magnet (4) on the appliance (see picture D).

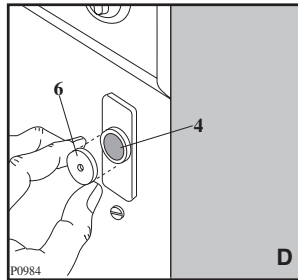

If the door has to be opened from left to right, invert the position of the plates (7), the magnet (4) and the plate (5) (Fig. B and E). Mount the counter-magnet (6) and the hinges (1) as previously described.

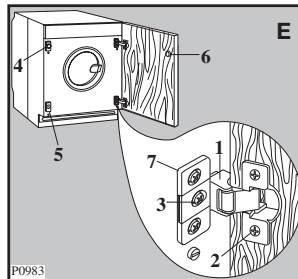

Recommendations regarding the construction and fitting of a base when the installation requires an integrated appliance to be raised.

Where the appliance has been raised by mounting onto a wooden base provided by the installer. The material used

44 electrolux installation

to construct the base should have a non slip surface, be water repellent and if possible be one solid piece.

If it is not possible to use one solid piece, due to the additional height required, ensure that any additional strips of timber are glued and screwed to the underside of the base (see Fig. F).

Drill four fixing holes see Fig. G.

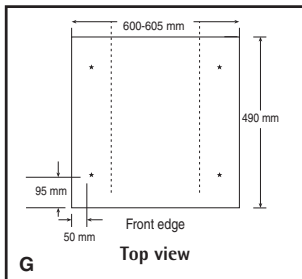

Position the base into the recess with its front edge as far forward as the adjoining plinth line will allow.

The reason for placing the base in this position is to allow a small strip of beading to be fitted in front of the appliance feet.

Fix the base firmly to the floor using four appropriate countersunk screws (see Fig. H).

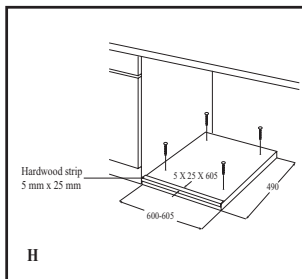

With the appliance installed adjust all four feet ensuring the machine is stable, and a clearance of approximately 5

mm is left between the top of the machine and the underside of the worktop.

A final check for stability should be carried out with the machine on spin with a load, this will identify the need for any further fine adjustment to the feet.

A strip of beading approximately 605 mm W, x 5 mm H, x 25 mm D must be screwed down into the base directly in front of the machine's feet, this will provide additional security.

If required an additional door magnet, part number 1242394-00/3 and disc, part number 1242393-00/5 are available from spare parts.

Environment concerns



Packaging materials

The materials marked with the symbol  are recyclable.

>PE<=polyethylene

>PS<=polystyrene

>PP<=polypropylene

This means that they can be recycled by disposing of them properly in appropriate collection containers.

Old machine

Use authorised disposal sites for your old appliance. Help to keep your country tidy!

The symbol  on the product or on its packaging indicates that this product may not be treated as household waste. Instead it should be taken to the appropriate collection point for the recycling of electrical and electronic equipment. By ensuring this product is disposed of correctly, you will help prevent potential negative consequences for the environment and human health, which could otherwise be caused by inappropriate waste handling of this product. For more detailed information about recycling of this product, please contact your local council, your household waste disposal service or the shop where you purchased the product.

Ecological hints



To save water, energy and to help protect the environment, we recommend that you follow these tips:

- Normally soiled laundry may be washed without prewashing in order to save detergent, water and time (the environment is protected too!).
- The machine works more economically if it is fully loaded.
- With adequate pre-treatment, stains and limited soiling can be removed; the laundry can then be washed at a lower temperature.
- Measure out detergent according to the water hardness, the degree of soiling and the quantity of laundry being washed.



www.electrolux.com

www.electrolux.co.uk

